

■ 特徵

- TBU系列的端子盤可配在TBR-N及TBU-N兩種導軌上。
- 採用框式壓線,材料為經淬火硬化並經鍍鋅鈍化的優質鋼板。
- 可搭配適合的短路片及標示牌,產品的設計符合IEC60947-7-1等國際標準。

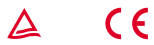

TBU-2.5N

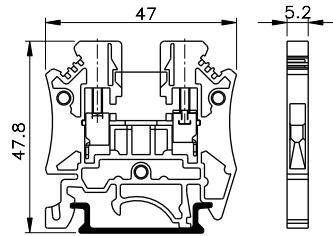
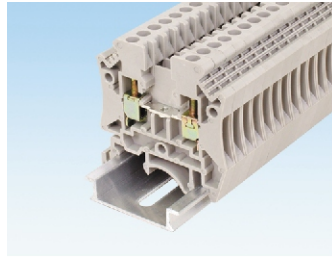

TBU-4N

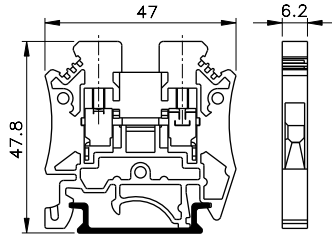
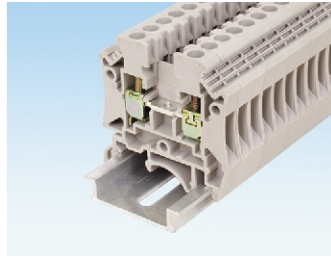

TBU-6N

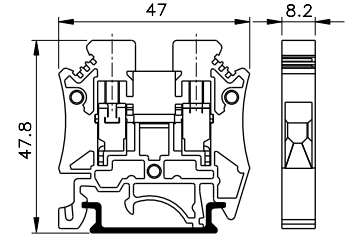

規格

額定電流

IEC

24A

IEC

32A

IEC

41A

額定電壓

800V

800V

800V

電線截面積

2.5mm²

4mm²

6mm²

單芯線

22-12AWG

22-10AWG

20-8 AWG

多芯線

22-12AWG

22-10AWG

20-8 AWG

耐電壓

5KV

5KV

5KV

扭力

4kgf.cm

6kgf.cm

10kgf.cm

螺絲

M2.6

M3

M3.5

剝線長度

10~12mm

10~12mm

10~12mm

配件

標示牌



型號

包裝數

TBU2.5N-A

100

型號

包裝數

TBU4N-A

100

型號

包裝數

TBU6N-A

100

擋片



TBU2.5N-F

50

TBU2.5N-F

50

TBU2.5N-F

50

側蓋



TBU2.5N-H

100

TBU2.5N-H

100

TBU2.5N-H

100

適用導軌



TBR-N(鋁)/TBR-S(鋼) 1M/條

TBR-N(鋁)/TBR-S(鋼) 1M/條

TBR-N(鋁)/TBR-S(鋼) 1M/條

上連接片



TBU2.5N-CU2 2P 50

TBU4N-CU2 2P 50

TBU6N-CU2 2P 50

TBU2.5N-CU3 3P 50

TBU4N-CU3 3P 50

TBU6N-CU3 3P 50

TBU2.5N-CU4 4P 50

TBU4N-CU4 4P 50

TBU6N-CU4 4P 50

TBU2.5N-CU10 10P 20

TBU4N-CU10 10P 20

TBU6N-CU10 10P 20

側連接片



TBU2.5N-CS2 2P 50

TBU4N-CS2 2P 50

TBU6N-CS2 2P 50

TBU2.5N-CS3 3P 50

TBU4N-CS3 3P 50

TBU6N-CS3 3P 50

TBU2.5N-CS4 4P 50

TBU4N-CS4 4P 50

TBU6N-CS4 4P 50

TBU2.5N-CS10 10P 20

TBU4N-CS10 10P 20

TBU6N-CS10 10P 20

TBU-10N

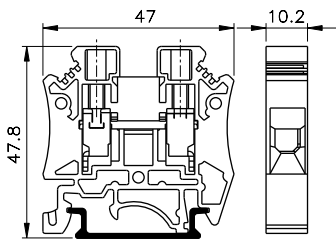
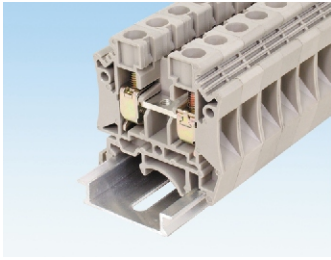

TBU-16N

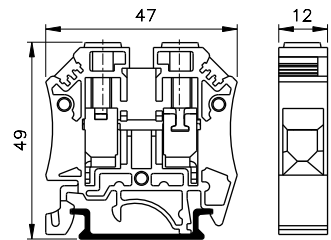
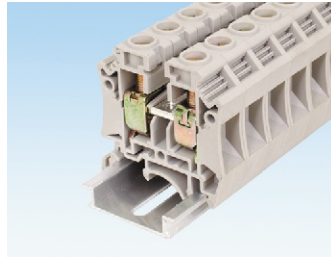

TBU-35N

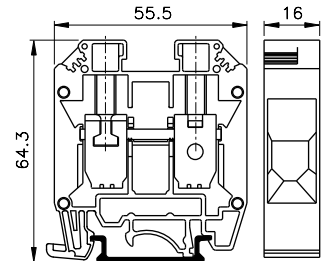
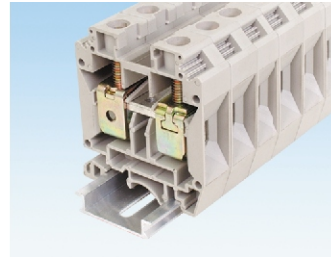

TBU-50N

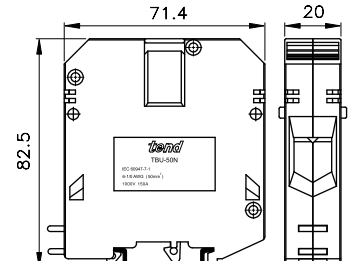
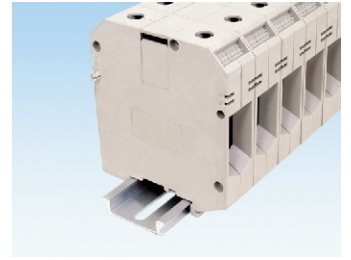

| |
|-------------------|
| IEC |
| 57A |
| 800V |
| 10mm ² |
| 16-6 AWG |
| 16-6 AWG |
| 5KV |
| 16kgf.cm |
| M4 |
| 10~12mm |

| |
|-------------------|
| IEC |
| 76A |
| 800V |
| 16mm ² |
| 14-6AWG |
| 14-6AWG |
| 5KV |
| 30kgf.cm |
| M5 |
| 10~12mm |

| |
|-------------------|
| IEC |
| 125A |
| 800V |
| 35mm ² |
| 12-2AWG |
| 12-2AWG |
| 5KV |
| 50kgf.cm |
| M6 |
| 15~20mm |

| |
|-------------------|
| IEC |
| 150A |
| 1000V |
| 50mm ² |
| 6-1/0AWG |
| 6-1/0AWG |
| 5KV |
| 50kgf.cm |
| M6 |
| 25~30mm |

| 型號 | 包裝數 |
|-------------------|------|
| TBU10N-A | 100 |
| TBU2.5N-F | 50 |
| TBU2.5N-H | 100 |
| TBR-N(鋁)/TBR-S(鋼) | 1M/條 |
| TBU10N-CU2 2P | 50 |
| TBU10N-CU3 3P | 50 |
| TBU10N-CU4 4P | 50 |
| TBU10N-CU10 10P | 20 |
| TBU10N-CS2 2P | 50 |
| TBU10N-CS3 3P | 50 |
| TBU10N-CS4 4P | 50 |
| TBU10N-CS10 10P | 20 |

| 型號 | 包裝數 |
|-------------------|------|
| TBU10N-A | 100 |
| TBU2.5N-F | 50 |
| TBU2.5N-H | 100 |
| TBR-N(鋁)/TBR-S(鋼) | 1M/條 |
| TBU16N-CU2 2P | 50 |
| TBU16N-CU3 3P | 50 |
| TBU16N-CU4 4P | 50 |
| TBU16N-CU10 10P | 10 |
| TBU16N-CS2 2P | 50 |
| TBU16N-CS3 3P | 50 |
| TBU16N-CS4 4P | 50 |
| TBU16N-CS10 10P | 10 |

| 型號 | 包裝數 |
|-------------------|------|
| TBU10N-A | 100 |
| TBU35N-F | 50 |
| TBU35N-H | 50 |
| TBR-N(鋁)/TBR-S(鋼) | 1M/條 |
| TBU35N-CU2 2P | 50 |
| TBU35N-CU3 3P | 50 |
| TBU35N-CU4 4P | 50 |
| TBU35N-CU10 10P | 10 |
| TBU35N-CS2 2P | 50 |
| TBU35N-CS3 3P | 50 |
| TBU35N-CS4 4P | 50 |
| TBU35N-CS10 10P | 10 |

| 型號 | 包裝數 |
|-------------------|------|
| TBU50N-A | 50 |
| TBU35N-F | 50 |
| TBR-N(鋁)/TBR-S(鋼) | 1M/條 |

■ 特徵

- TBU&TBE系列的端子盤可配在 TBR-N 及 TBU-N兩種導軌上。
- 採用框式壓線,材料為經淬火硬化並經鍍鋅鈍化的優質鋼板。
- 可搭配適合的短路片及標示牌,產品的設計符合IEC60947-7-1等國際標準。

TBU-70N

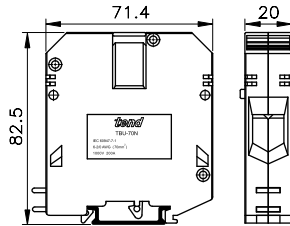
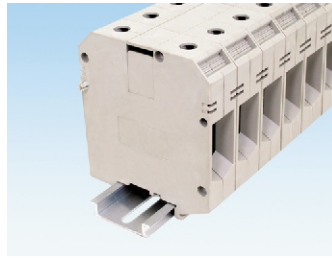

TBU-95N

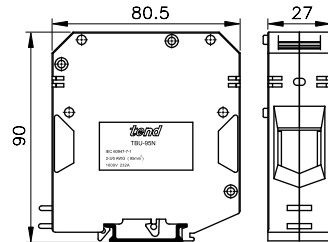
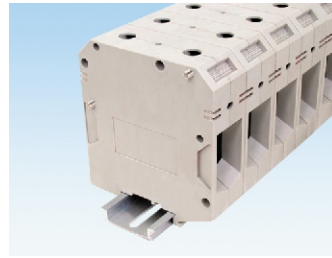

TBU-150N

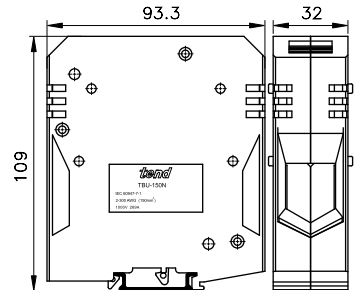
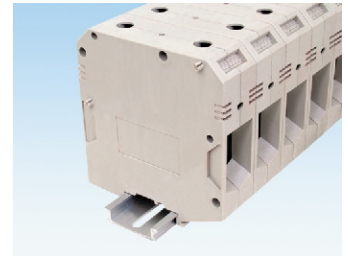

規格

額定電流

IEC

200A

IEC

232A

IEC

269A

額定電壓

1000V

1000V

1000V

電線截面積

70mm²

95mm²

150mm²

單芯線

6-2/0 AWG

2-3/0AWG

2-300AWG

多芯線

6-2/0 AWG

2-3/0AWG

2-300AWG

耐電壓

5KV

5KV

5KV

扭力

50kgf.cm

90kgf.cm

165kgf.cm

螺絲

M6

M8

M10

剝線長度

25~30mm

30~35mm

35~40mm

配件

標示牌



型號

包裝數

TBU50N-A

50

型號

包裝數

TBU50N-A

50

型號

包裝數

TBU50N-A

50

擋片



TBU35N-F

50

TBU35N-F

50

TBU35N-F

50

適用導軌



TBR-N(鋁)/TBR-S(鋼) 1M/條

TBR-N(鋁)/TBR-S(鋼) 1M/條

TBR-N(鋁)/TBR-S(鋼) 1M/條

■ 特徵

- TBE系列的端子盤可配在TBR-N及TBU-N兩種導軌上。
- 採用框式壓線,材料為經淬火硬化並經鍍鋅鈍化的優質鋼板。
- 可搭配適合的短路片及標示牌,產品的設計符合IEC60947-7-2等國際標準。

TBE-2.5N

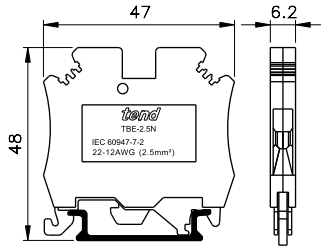
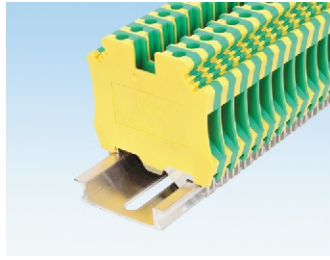

TBE-4N

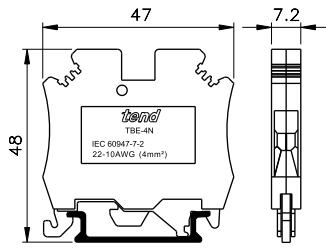
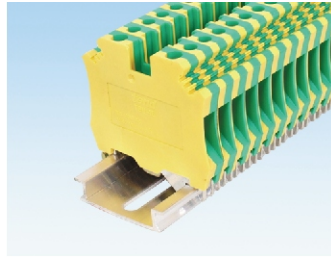

TBE-6N

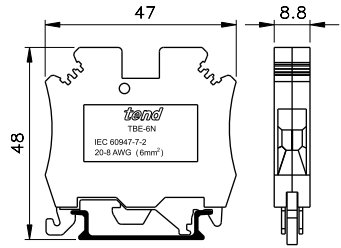

| 規格 | IEC | | IEC | | IEC | |
|--|--------------------|------|-------------------|------|-------------------|------|
| 額定電流 | 24A | | 32A | | 41A | |
| 電線截面積 | 2.5mm ² | | 4mm ² | | 6mm ² | |
| 單芯線 | 22-12AWG | | 22-10AWG | | 20-8 AWG | |
| 多芯線 | 22-12AWG | | 22-10AWG | | 20-8 AWG | |
| 耐電壓 | 5KV | | 5KV | | 5KV | |
| 扭力 | 4kgf.cm | | 6kgf.cm | | 10kgf.cm | |
| 螺絲 | M2.6 | | M3 | | M3.5 | |
| 剝線長度 | 10~12mm | | 10~12mm | | 10~12mm | |
| 配件 | 型號 | 包裝數 | 型號 | 包裝數 | 型號 | 包裝數 |
| 標示牌  | TBU4N-A | 100 | TBU4N-A | 100 | TBU6N-A | 100 |
| 擋片  | TBU2.5N-F | 50 | TBU2.5N-F | 50 | TBU2.5N-F | 50 |
| 適用導軌  | TBR-N(鋁)/TBR-S(鋼) | 1M/條 | TBR-N(鋁)/TBR-S(鋼) | 1M/條 | TBR-N(鋁)/TBR-S(鋼) | 1M/條 |
| | | | | | | |
| | | | | | | |
| | | | | | | |
| | | | | | | |
| | | | | | | |
| | | | | | | |
| | | | | | | |
| | | | | | | |
| | | | | | | |
| | | | | | | |

■ 特徵

- TBE系列的端子盤可配在TBR-N及TBU-N兩種導軌上。
- 採用框式壓線,材料為經淬火硬化並經鍍鋅鈍化的優質鋼板。
- 可搭配適合的短路片及標示牌,產品的設計符合IEC60947-7-2等國際標準。

TBE-10N

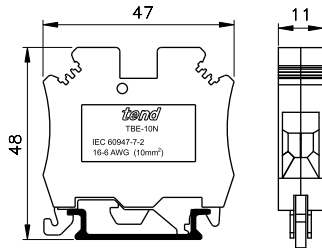

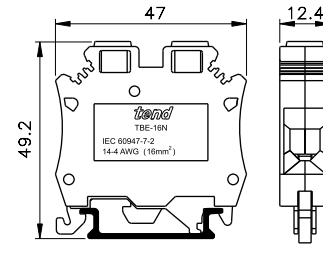
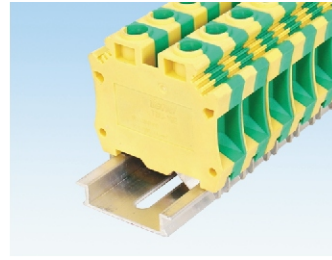

TBE-16N

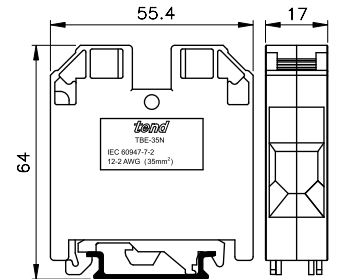
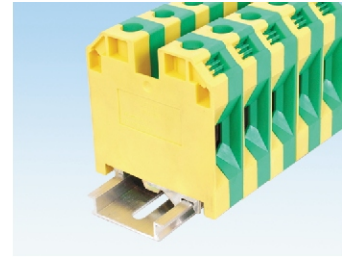

TBE-35N



| 規格 | IEC | | IEC | | IEC | |
|--|------------------------|-----|------------------------|-----|------------------------|-----|
| 額定電流 | 57A | | 76A | | 125A | |
| 電線截面積 | 10mm ² | | 16mm ² | | 35mm ² | |
| 單芯線 | 16-6AWG | | 14-6AWG | | 12-2AWG | |
| 多芯線 | 16-6 AWG | | 14-6AWG | | 12-2AWG | |
| 耐電壓 | 5KV | | 5KV | | 5KV | |
| 扭力 | 16kgf.cm | | 30kgf.cm | | 50kgf.cm | |
| 螺絲 | M4 | | M5 | | M6 | |
| 剝線長度 | 10~12mm | | 10~12mm | | 15~20mm | |
| 配件 | 型號 | 包裝數 | 型號 | 包裝數 | 型號 | 包裝數 |
| 標示牌  | TBU10N-A | 100 | TBU10N-A | 100 | TBU10N-A | 100 |
| 擋片  | TBU2.5N-F | 50 | TBU2.5N-F | 50 | TBU35N-F | 50 |
| 適用導軌  | TBR-N(鋁)/TBR-S(鋼) 1M/條 | | TBR-N(鋁)/TBR-S(鋼) 1M/條 | | TBR-N(鋁)/TBR-S(鋼) 1M/條 | |
| | | | | | | |
| | | | | | | |
| | | | | | | |
| | | | | | | |
| | | | | | | |
| | | | | | | |
| | | | | | | |
| | | | | | | |
| | | | | | | |
| | | | | | | |

TBE-50N

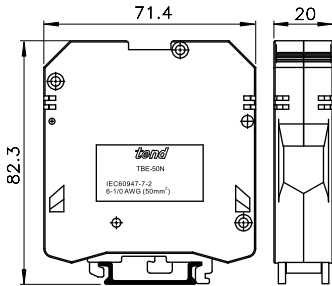
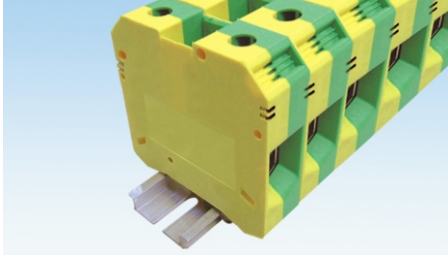

TBE-70N

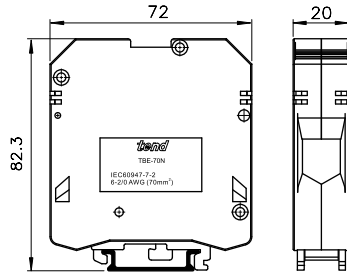
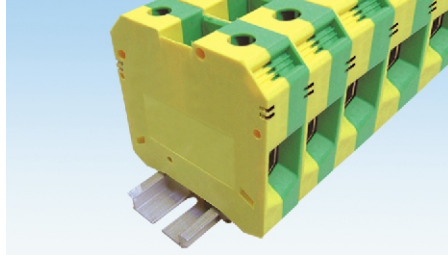

TBE-95N

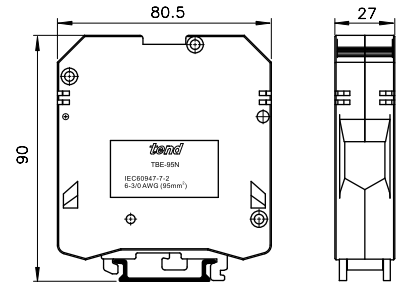
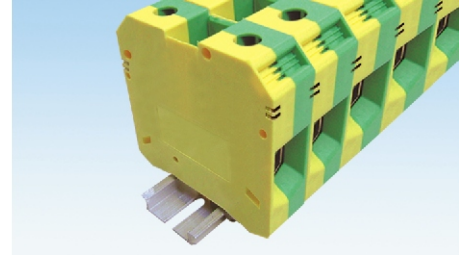

| |
|-------------------|
| IEC |
| 150A |
| 50mm ² |
| 6-1/0AWG |
| 6-1/0AWG |
| 5KV |
| 50kgf.cm |
| M6 |
| 25~30mm |

| |
|-------------------|
| IEC |
| 200A |
| 70mm ² |
| 6-2/0 AWG |
| 6-2/0 AWG |
| 5KV |
| 50kgf.cm |
| M6 |
| 25~30mm |

| |
|-------------------|
| IEC |
| 232A |
| 95mm ² |
| 2-3/0AWG |
| 2-3/0AWG |
| 5KV |
| 90kgf.cm |
| M8 |
| 30~35mm |

| 型號 | 包裝數 |
|----|-----|
|----|-----|

| | |
|-------------------|------|
| TBU50N-A | 50 |
| TBU35N-F | 50 |
| TBR-N(鋁)/TBR-S(鋼) | 1M/條 |
| | |
| | |
| | |
| | |
| | |
| | |
| | |
| | |

| 型號 | 包裝數 |
|----|-----|
|----|-----|

| | |
|-------------------|------|
| TBU50N-A | 50 |
| TBU35N-F | 50 |
| TBR-N(鋁)/TBR-S(鋼) | 1M/條 |
| | |
| | |
| | |
| | |
| | |
| | |
| | |
| | |

| 型號 | 包裝數 |
|----|-----|
|----|-----|

| | |
|-------------------|------|
| TBU50N-A | 50 |
| TBU35N-F | 50 |
| TBR-N(鋁)/TBR-S(鋼) | 1M/條 |
| | |
| | |
| | |
| | |
| | |
| | |
| | |
| | |

■ 特徵

- TBT閘刀式及TBFV(H)系列的保險絲端子盤可裝配在TBR-N及TBU-N兩種導軌上。
- 採用框式壓線,材料為經淬火硬化並經鍍鋅鈍化的優質鋼板。
- 可搭配適合的標示牌,產品的設計符合IEC60947-7-3等國際標準。

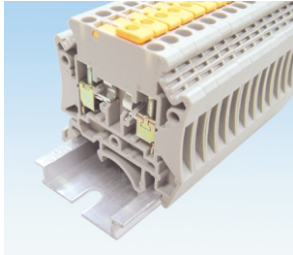
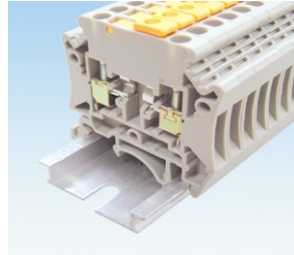
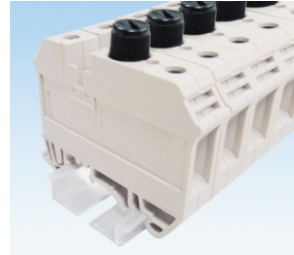
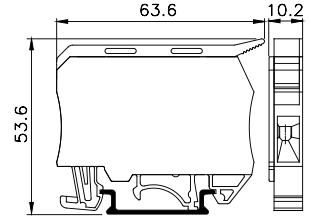
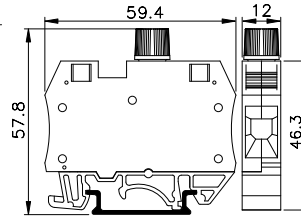
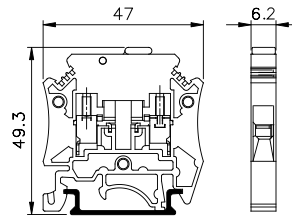
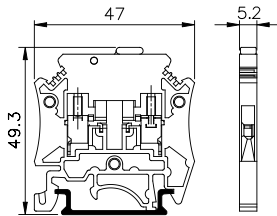
TBT-2.5N(閘刀式)

TBT-4N(閘刀式)

**TBFV(立式保險絲)
TBFV-1/TBFV-2(附LED)**

**TBFH(臥式保險絲)
TBFH-1/TBFH-2(附LED)**

| 規格 | IEC | | IEC | | IEC | | IEC | |
|-------|---------------------------|--------|-----------------------|--------|--------------------------|--------|-----------------------|-----|
| 額定電流 | 10A | | 16A | | 10A | | 6.3A | |
| 額定電壓 | 400V | | 400V | | 500V | | 400V | |
| 電線截面積 | 2.5mm ² | | 4mm ² | | 10mm ² | | 4mm ² | |
| 單芯線 | 22-12AWG | | 22-10AWG | | 16-6AWG | | 22-10AWG | |
| 多芯線 | 22-12AWG | | 22-10AWG | | 16-6AWG | | 22-10AWG | |
| 耐電壓 | 5KV | | 5KV | | 5KV | | 5KV | |
| 扭力 | 4kgf.cm | | 6kgf.cm | | 16kgf.cm | | 6kgf.cm | |
| 螺絲 | M2.6 | | M3 | | M4 | | M3 | |
| 剝線長度 | 10~12mm | | 10~12mm | | 10~12mm | | 10~12mm | |
| 保險絲規格 | —— | | —— | | Ø5X20 | | Ø5X20/Ø5X25 | |
| 配件 | 型號 | 包裝數 | 型號 | 包裝數 | 型號 | 包裝數 | 型號 | 包裝數 |
| 標示牌 | TBU2.5N-A | 100 | TBU4N-A | 100 | TBU10N-A | 100 | TBU6N-A | 100 |
| 擋片 | TBU2.5N-F | 50 | TBU2.5N-F | 50 | TBU2.5N-F | 50 | TBU2.5N-F | 50 |
| 側蓋 | TBU2.5N-H | 100 | TBU2.5N-H | 100 | —— | —— | —— | —— |
| 適用導軌 | TBR-N(鋁)/TBR-S(鋼)1M/條 | | TBR-N(鋁)/TBR-S(鋼)1M/條 | | TBR-N(鋁)/TBR-S(鋼)1M/條 | | TBR-N(鋁)/TBR-S(鋼)1M/條 | |
| 上連接片 | —— | | —— | | TBU16N-CU2 | 2P 50 | —— | |
| | —— | | —— | | TBU16N-CU3 | 3P 50 | —— | |
| 側連接片 | TBU2.5N-CS2 | 2P 50 | TBU4N-CS2 | 2P 50 | TBU16N-CS2 | 2P 50 | —— | |
| | TBU2.5N-CS3 | 3P 50 | TBU4N-CS3 | 3P 50 | TBU16N-CS3 | 3P 50 | —— | |
| | TBU2.5N-CS4 | 4P 50 | TBU4N-CS4 | 4P 50 | TBU16N-CS4 | 4P 50 | —— | |
| | TBU2.5N-CS10 | 10P 20 | TBU4N-CS10 | 10P 20 | TBU16N-CS10 | 10P 10 | —— | |
| 規格 | 說 明 | | | | | | | |
| 附LED | TBFV-1/TBFH-1:10~30VAC/DC | | | | TBFV-2/TBFH-2:110~250VAC | | | |

■ 配 件

材質： PA66尼龍
 工作溫度範圍： -40°C~+100°C

注：包裝數量100.PCS(10PCS 為一條)
 TBU-50N為單PCS(無整條)

標示牌

| (TBU-2.5N用) | | (TBU-4N用) | | (TBU-6N用) | | (TBU-10N, TB-16N, TB-35N用) | | 說明 | 包裝數 |
|---------------|-------------|-------------|--------------|---------------|-----|----------------------------|----|----|-----|
| 型號 | 型號 | 型號 | 型號 | 型號 | 型號 | 型號 | 型號 | | |
| TBU2.5N-A | TBU4N-A | TBU6N-A | TBU10N-A | 空白 | 100 | | | | |
| TBU2.5N-A1 | TBU4N-A1 | TBU6N-A1 | TBU10N-A1 | 1 | 100 | | | | |
| TBU2.5N-A2 | TBU4N-A2 | TBU6N-A2 | TBU10N-A2 | 2 | 100 | | | | |
| TBU2.5N-A3 | TBU4N-A3 | TBU6N-A3 | TBU10N-A3 | 3 | 100 | | | | |
| TBU2.5N-A4 | TBU4N-A4 | TBU6N-A4 | TBU10N-A4 | 4 | 100 | | | | |
| TBU2.5N-A5 | TBU4N-A5 | TBU6N-A5 | TBU10N-A5 | 5 | 100 | | | | |
| TBU2.5N-A6 | TBU4N-A6 | TBU6N-A6 | TBU10N-A6 | 6 | 100 | | | | |
| TBU2.5N-A7 | TBU4N-A7 | TBU6N-A7 | TBU10N-A7 | 7 | 100 | | | | |
| TBU2.5N-A8 | TBU4N-A8 | TBU6N-A8 | TBU10N-A8 | 8 | 100 | | | | |
| TBU2.5N-A0 | TBU4N-A0 | TBU6N-A0 | TBU10N-A0 | 0 | 100 | | | | |
| TBU2.5N-A18 | TBU4N-A18 | TBU6N-A18 | TBU10N-A18 | 18 | 100 | | | | |
| TBU2.5N-A21 | TBU4N-A21 | TBU6N-A21 | TBU10N-A21 | 21 | 100 | | | | |
| TBU2.5N-A22 | TBU4N-A22 | TBU6N-A22 | TBU10N-A22 | 22 | 100 | | | | |
| TBU2.5N-A23 | TBU4N-A23 | TBU6N-A23 | TBU10N-A23 | 23 | 100 | | | | |
| TBU2.5N-A24 | TBU4N-A24 | TBU6N-A24 | TBU10N-A24 | 24 | 100 | | | | |
| TBU2.5N-A41 | TBU4N-A41 | TBU6N-A41 | TBU10N-A41 | 41 | 100 | | | | |
| TBU2.5N-A42 | TBU4N-A42 | TBU6N-A42 | TBU10N-A42 | 42 | 100 | | | | |
| TBU2.5N-AR | TBU4N-AR | TBU6N-AR | TBU10N-AR | R | 100 | | | | |
| TBU2.5N-AS | TBU4N-AS | TBU6N-AS | TBU10N-AS | S | 100 | | | | |
| TBU2.5N-AT | TBU4N-AT | TBU6N-AT | TBU10N-AT | T | 100 | | | | |
| TBU2.5N-AU-1 | TBU4N-AU-1 | TBU6N-AU-1 | TBU10N-AU-1 | U | 100 | | | | |
| TBU2.5N-AV | TBU4N-AV | TBU6N-AV | TBU10N-AV | V | 100 | | | | |
| TBU2.5N-AW | TBU4N-AW | TBU6N-AW | TBU10N-AW | W | 100 | | | | |
| TBU2.5N-AG | TBU4N-AG | TBU6N-AG | TBU10N-AG | G | 100 | | | | |
| TBU2.5N-A0110 | TBU4N-A0110 | TBU6N-A0110 | TBU10N-A0110 | 1~10 | 100 | | | | |
| TBU2.5N-A1120 | TBU4N-A1120 | TBU6N-A1120 | TBU10N-A1120 | 11~20 | 100 | | | | |
| TBU2.5N-A2130 | TBU4N-A2130 | TBU6N-A2130 | TBU10N-A2130 | 21~30 | 100 | | | | |
| TBU2.5N-A3140 | TBU4N-A3140 | TBU6N-A3140 | TBU10N-A3140 | 31~40 | 100 | | | | |
| TBU2.5N-A4150 | TBU4N-A4150 | TBU6N-A4150 | TBU10N-A4150 | 41~50 | 100 | | | | |
| TBU2.5N-AL | TBU4N-AL | TBU6N-AL | TBU10N-AL | L1,L2,L3,N,PE | 100 | | | | |
| TBU2.5N-AU | TBU4N-AU | TBU6N-AU | TBU10N-AU | U,V,W,N ⊕ | 100 | | | | |

標示牌(TBU-50N,70N,95N,150N用)

| 型號 | 說明 | 包裝數 |
|------------|----|-----|
| TBU50N-A | 空白 | 50 |
| TBU50N-A1 | 1 | 50 |
| TBU50N-A2 | 2 | 50 |
| TBU50N-A3 | 3 | 50 |
| TBU50N-A4 | 4 | 50 |
| TBU50N-A5 | 5 | 50 |
| TBU50N-A6 | 6 | 50 |
| TBU50N-A7 | 7 | 50 |
| TBU50N-A8 | 8 | 50 |
| TBU50N-A0 | 0 | 50 |
| TBU50N-AL1 | L1 | 50 |
| TBU50N-AL2 | L2 | 50 |
| TBU50N-AL3 | L3 | 50 |
| TBU50N-AN | N | 50 |
| TBU50N-APE | PE | 50 |
| TBU50N-AU | U | 50 |
| TBU50N-AV | V | 50 |
| TBU50N-AW | W | 50 |
| TBU50N-AE | ⊕ | 50 |

| | | | | | | | | | |
|----|----|----|---|----|----|----|----|---|----|
| | | | | | | | | | |
| 1 | 1 | 1 | 1 | 1 | 1 | 1 | 1 | 1 | 1 |
| 1 | 2 | 3 | 4 | 5 | 6 | 7 | 8 | 9 | 10 |
| L1 | L2 | L3 | N | PE | L1 | L2 | L3 | N | PE |
| U | V | W | N | ⊕ | U | V | W | N | ⊕ |

■ 配件

TBU N-CU 上連接片

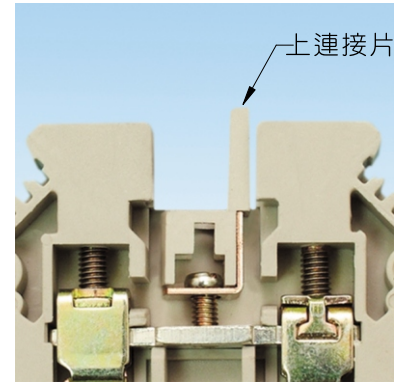
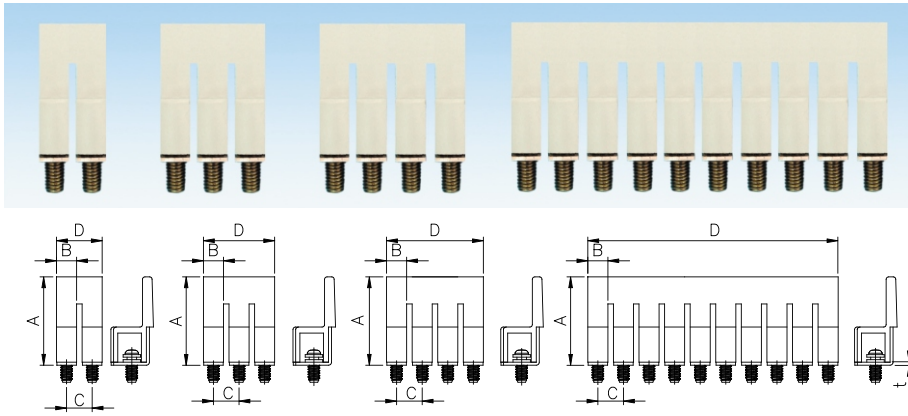

| 上連接片型號 | P數 | 適用端子盤 | 包裝數量 | 尺寸(見上圖) | | | | | 上連接片型號 | P數 | 適用端子盤 | 包裝數量 | 尺寸(見上圖) | | | | |
|--------------|----|----------|------|---------|-----|-----|------|-----|-------------|----|---------|------|---------|------|------|-------|-----|
| | | | | A | B | C | D | t | | | | | A | B | C | D | t |
| TBU2.5N-CU2 | 2 | TBU-2.5N | 50 | 17.8 | 4 | 5.1 | 9.1 | 0.6 | TBU10N-CU2 | 2 | TBU-10N | 50 | 24.9 | 8 | 10.2 | 18.2 | 1 |
| TBU2.5N-CU3 | 3 | TBU-2.5N | 50 | 17.8 | 4 | 5.1 | 14.2 | 0.6 | TBU10N-CU3 | 3 | TBU-10N | 50 | 24.9 | 8 | 10.2 | 28.4 | 1 |
| TBU2.5N-CU4 | 4 | TBU-2.5N | 50 | 17.8 | 4 | 5.1 | 19.3 | 0.6 | TBU10N-CU4 | 4 | TBU-10N | 50 | 24.9 | 8 | 10.2 | 38.6 | 1 |
| TBU2.5N-CU10 | 10 | TBU-2.5N | 20 | 17.8 | 4 | 5.1 | 49.9 | 0.6 | TBU10N-CU10 | 10 | TBU-10N | 20 | 24.9 | 8 | 10.2 | 99.8 | 1 |
| TBU4N-CU2 | 2 | TBU-4N | 50 | 18.2 | 4.5 | 6.2 | 10.7 | 1 | TBU16N-CU2 | 2 | TBU-16N | 50 | 26.2 | 9.4 | 12 | 21.4 | 1 |
| TBU4N-CU3 | 3 | TBU-4N | 50 | 18.2 | 4.5 | 6.2 | 16.9 | 1 | TBU16N-CU3 | 3 | TBU-16N | 50 | 26.2 | 9.4 | 12 | 33.4 | 1 |
| TBU4N-CU4 | 4 | TBU-4N | 50 | 18.2 | 4.5 | 6.2 | 23.1 | 1 | TBU16N-CU4 | 4 | TBU-16N | 50 | 26.2 | 9.4 | 12 | 45.4 | 1 |
| TBU4N-CU10 | 10 | TBU-4N | 20 | 18.2 | 4.5 | 6.2 | 60.3 | 1 | TBU16N-CU10 | 10 | TBU-16N | 10 | 26.2 | 9.4 | 12 | 117.4 | 1 |
| TBU6N-CU2 | 2 | TBU-6N | 50 | 18.2 | 6.2 | 8.2 | 14.4 | 1 | TBU35N-CU2 | 2 | TBU-35N | 50 | 26.8 | 11.5 | 15.9 | 27.4 | 1.6 |
| TBU6N-CU3 | 3 | TBU-6N | 50 | 18.2 | 6.2 | 8.2 | 22.6 | 1 | TBU35N-CU3 | 3 | TBU-35N | 50 | 26.8 | 11.5 | 15.9 | 43.3 | 1.6 |
| TBU6N-CU4 | 4 | TBU-6N | 50 | 18.2 | 6.2 | 8.2 | 30.8 | 1 | TBU35N-CU4 | 4 | TBU-35N | 50 | 26.8 | 11.5 | 15.9 | 59.2 | 1.6 |
| TBU6N-CU10 | 10 | TBU-6N | 20 | 18.2 | 6.2 | 8.2 | 80.0 | 1 | TBU35N-CU10 | 10 | TBU-35N | 10 | 26.8 | 11.5 | 15.9 | 154.6 | 1.6 |

TBU N-CS 側連接片

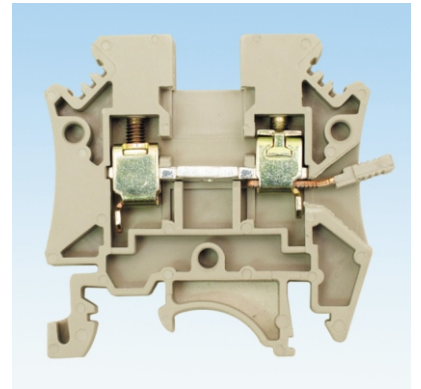
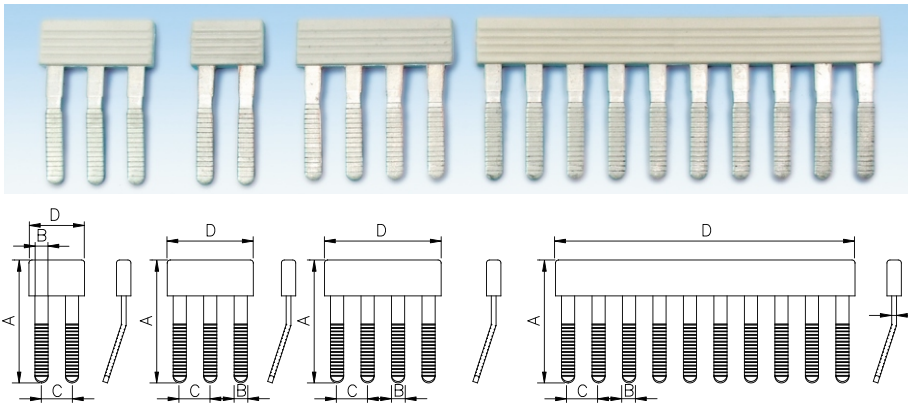

| 側連接片型號 | P數 | 適用端子盤 | 包裝數量 | 尺寸(見上圖) | | | | | 側連接片型號 | P數 | 適用端子盤 | 包裝數量 | 尺寸(見上圖) | | | | |
|--------------|----|----------|------|---------|-----|-----|------|-----|-------------|----|---------|------|---------|-----|------|-------|-----|
| | | | | A | B | C | D | t | | | | | A | B | C | D | t |
| TBU2.5N-CS2 | 2 | TBU-2.5N | 50 | 20.6 | 2.2 | 5.1 | 9.3 | 0.8 | TBU10N-CS2 | 2 | TBU-10N | 50 | 29.4 | 5.4 | 10.2 | 18.4 | 1.6 |
| TBU2.5N-CS3 | 3 | TBU-2.5N | 50 | 20.6 | 2.2 | 5.1 | 14.4 | 0.8 | TBU10N-CS3 | 3 | TBU-10N | 50 | 29.4 | 5.4 | 10.2 | 28.6 | 1.6 |
| TBU2.5N-CS4 | 4 | TBU-2.5N | 50 | 20.6 | 2.2 | 5.1 | 19.5 | 0.8 | TBU10N-CS4 | 4 | TBU-10N | 50 | 29.4 | 5.4 | 10.2 | 38.8 | 1.6 |
| TBU2.5N-CS10 | 10 | TBU-2.5N | 20 | 20.6 | 2.2 | 5.1 | 50.1 | 0.8 | TBU10N-CS10 | 10 | TBU-10N | 20 | 29.4 | 5.4 | 10.2 | 100 | 1.6 |
| TBU4N-CS2 | 2 | TBU-4N | 50 | 21.5 | 2.5 | 6.2 | 10.7 | 1 | TBU16N-CS2 | 2 | TBU-16N | 50 | 31 | 6.6 | 12 | 21 | 1.6 |
| TBU4N-CS3 | 3 | TBU-4N | 50 | 21.5 | 2.5 | 6.2 | 16.9 | 1 | TBU16N-CS3 | 3 | TBU-16N | 50 | 31 | 6.6 | 12 | 33 | 1.6 |
| TBU4N-CS4 | 4 | TBU-4N | 50 | 21.5 | 2.5 | 6.2 | 23.1 | 1 | TBU16N-CS4 | 4 | TBU-16N | 50 | 31 | 6.6 | 12 | 45 | 1.6 |
| TBU4N-CS10 | 10 | TBU-4N | 20 | 21.5 | 2.5 | 6.2 | 60.3 | 1 | TBU16N-CS10 | 10 | TBU-16N | 10 | 31 | 6.6 | 12 | 117 | 1.6 |
| TBU6N-CS2 | 2 | TBU-6N | 50 | 23.8 | 3.6 | 8.2 | 14.8 | 1.2 | TBU35N-CS2 | 2 | TBU-35N | 50 | 37.2 | 8.4 | 15.9 | 29.6 | 1.6 |
| TBU6N-CS3 | 3 | TBU-6N | 50 | 23.8 | 3.6 | 8.2 | 23 | 1.2 | TBU35N-CS3 | 3 | TBU-35N | 50 | 37.2 | 8.4 | 15.9 | 45.6 | 1.6 |
| TBU6N-CS4 | 4 | TBU-6N | 50 | 23.8 | 3.6 | 8.2 | 31.2 | 1.2 | TBU35N-CS4 | 4 | TBU-35N | 50 | 37.2 | 8.4 | 15.9 | 61.6 | 1.6 |
| TBU6N-CS10 | 10 | TBU-6N | 20 | 23.8 | 3.6 | 8.2 | 80.4 | 1.2 | TBU35N-CS10 | 10 | TBU-35N | 10 | 37.2 | 8.4 | 15.9 | 157.6 | 1.6 |

■ 配件

TBU2.5N-H
TBU-2.5N側蓋 (適用於TBU-2.5N~16N)

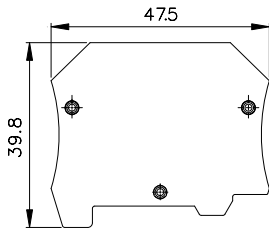

TBU35N-H
TBU-35N側蓋 (適用於TBU-35N)

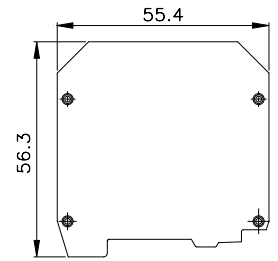
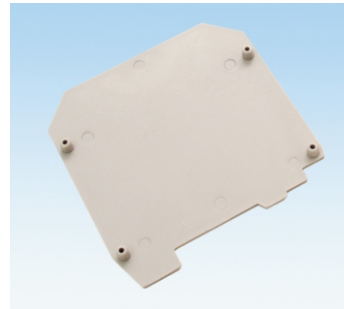

TBU2.5N-F
TBU-2.5N擋片 (適用於2.5N~16N)

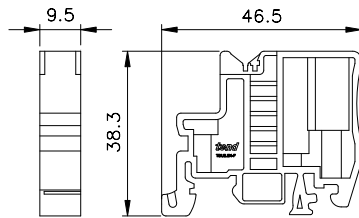
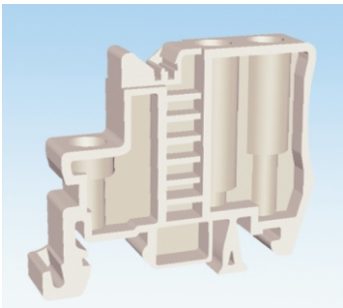

TBU35N-F
TBU-35N擋片 (適用於35N~150N)

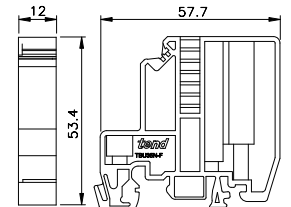

TBU2.5N-K
TBU-2.5N分隔片 (適用於TBU-2.5N~16N)

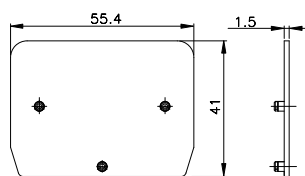

TBU2.5N-B
TBU-2.5N擋片標示牌

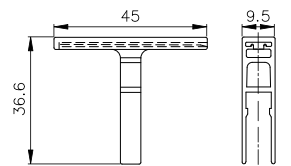

TBR-N 鋁軌
TBR-S 鋼軌

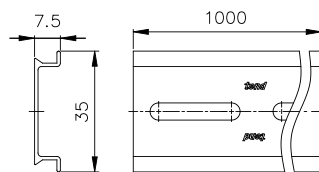
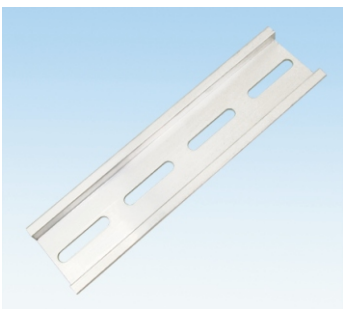

TBU2.5N-T
TBU-2.5N 標記牌

