

## ■ 特性

本保險絲座可固定於 TBR-N 導軌上或直接鎖於面板上,連接導線為 1.5mm<sup>2</sup>~8mm<sup>2</sup> 更換保險絲時,需先切斷電源;附指示燈系列在保險絲熔斷時,指示燈會亮起。

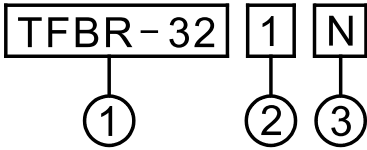

## ■ 型號說明



項次	代號	說明
1.型式	TFBR-32	軌道式保險絲座
2.極數	1 2 3	一極 雙極 三極
3.指示燈	N 空白	110~500 VAC 無指示燈

## ■ 規格

額定電壓	額定電流	周圍溫度	周圍濕度	應用	保險絲尺寸
600 VAC max.	32A max.	-20°C至+80°C	95%相對濕度	導線保護·電動機保護	Ø10X38

## ■ 外型尺寸

## ■ 接線符號

TFBR-321N

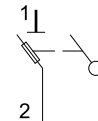
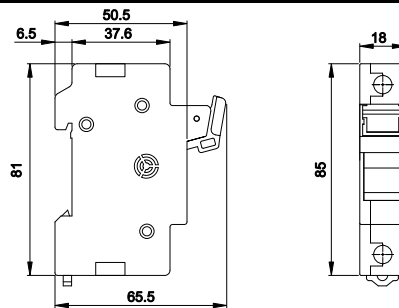

TFBR-322N

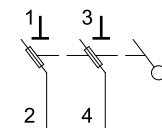
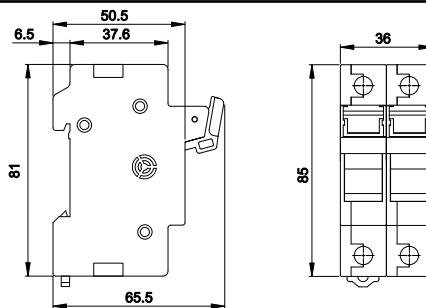

TFBR-323N

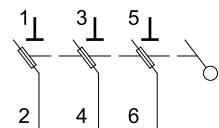
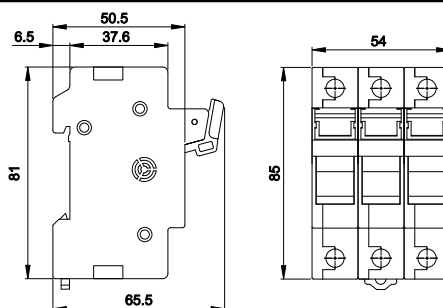

## ■ 無指示燈系列

TFBR-321



TFBR-322



TFBR-323



TFB-101N (110V,220V透明,24V黃色)

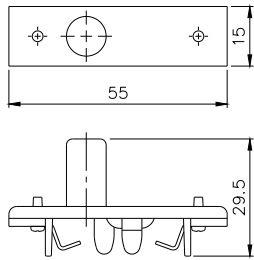

TFE-16N

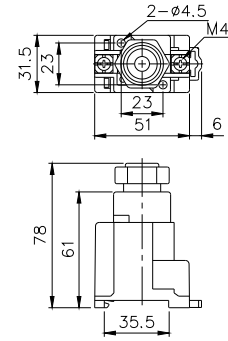

TFBR-101 (可用於TBR-N軌道)

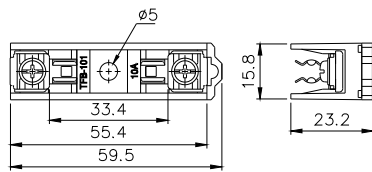

TFBR-102 (可用於TBR-N軌道)

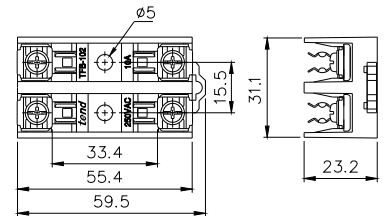
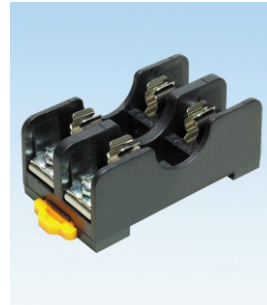

TFB-101

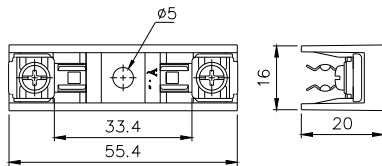

TFB-102

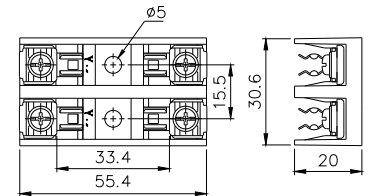

TFB-301

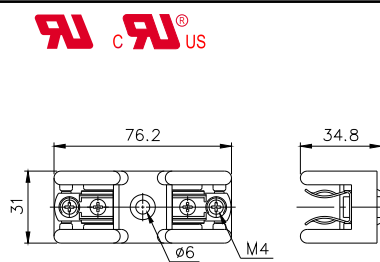

TFB-303

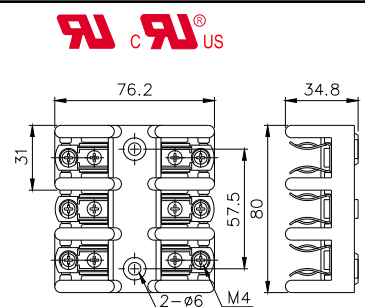

TFB-15

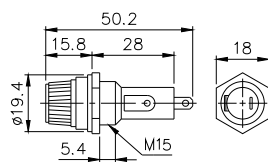

TFU-50(1A~50A)

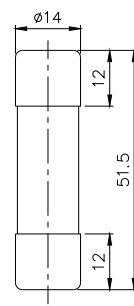

TFU-16(2A~30A)

